

Nakamichi **BX-2**

2 Head Cassette Deck

Owner's Manual

As the colours of the wires in the mains lead of this apparatus may not correspond with the coloured markings identifying the terminals in your plug proceed as follows.
The wire which is coloured **BLUE** must be connected to the terminal which is marked with the letter **N** or coloured **BLACK**.
The wire which is coloured **BROWN** must be connected to the terminal which is marked with the letter **L**, or coloured **RED**.

IMPORTANT

THE WIRES IN THIS MAINS LEAD ARE COLOURED IN ACCORDANCE WITH THE FOLLOWING CODE

BLUE
BROWN

NEUTRAL
LIVE

M-3844

Congratulations!

You have chosen a very fine cassette deck.

The Nakamichi BX-2 was developed on the basis of this company's extensive experience with high-grade cassette decks. While incorporating much of Nakamichi's superior technology and following its sound policy, this basic model delivers high overall characteristics and represents an extraordinary value at a moderate price.

Please take the time to read this manual in its entirety to fully acquaint yourself with this cassette deck.

Thank you.

Nakamichi Corporation.

CONTENTS

- Connections 2
- Safety Instructions..... 3
- On Cassette Tapes 5
- Controls and Features 5
- Precautions 5
- Operation 5
 - Playback 5
 - Matching the Deck to Various Cassette Tapes 5
 - Recording 6
 - Timer Recording or Playback..... 6
- Maintenance 7
- Troubleshooting..... 7
- Specifications..... 8



CAUTION
RISK OF ELECTRIC SHOCK. DO NOT OPEN!





The lightning flash with arrowhead symbol, within an equilateral triangle, is intended to alert the user of the presence of uninsulated "dangerous voltage" within the product's enclosure; that may be of sufficient magnitude to constitute a risk of electric shock to persons.

CAUTION

TO REDUCE THE RISK OF ELECTRIC SHOCK, DO NOT REMOVE COVER (OR BACK). NO USER-SERVICEABLE PARTS INSIDE. REFER SERVICING TO QUALIFIED SERVICE PERSONNEL.



The exclamation point within an equilateral triangle is intended to alert the user of the presence of important operating and maintenance (servicing) instructions, in the literature accompanying the appliance.

WARNING

TO PREVENT FIRE OR SHOCK HAZARD, DO NOT EXPOSE THIS APPLIANCE TO RAIN OR MOISTURE.

Please record the Model Number and Serial Number in the space provided below and retain these numbers. Model Number and Serial Number are located on the rear panel of the unit.

Model Number: Nakamichi BX-2

Serial Number: 18829

Connections

After consulting the instructions for your amplifier or receiver, use the shielded cables with RCA plugs (provided with the deck) to make connections as shown in the chart. Take care not to mix up left and right channels. While making connections, the power to the deck and to the amplifier should be switched off.

Headphones

Standard stereo headphones with an impedance of 8~150 ohms may be connected to the headphone jack.

Microphone Connections

The BX-2 possesses only line input facilities. When microphones are to be used for recording, a separate microphone mixer with a line output must be connected to this deck's line input terminals.

Nakamichi offers the optional MX-100 Microphone Mixer, which provides three inputs for left, right and center blend (L+R) microphones. To power the MX-100, the separate PS-100 Power Supply is required.

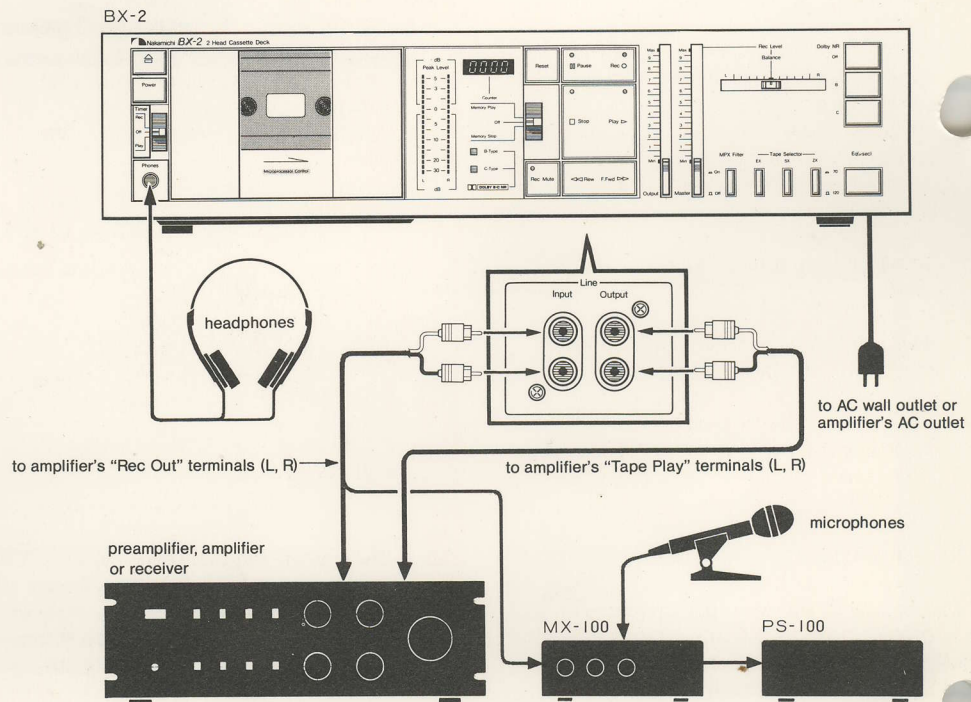

Safety Instructions

Following safety instructions have been included in compliance with safety standard regulations. Please read them carefully.

1. Read Instructions — All the safety and operating instructions should be read before the appliance is operated.
2. Retain instructions — The safety and operating instructions should be retained for future reference.
3. Heed Warnings — All warnings on the appliance and in the operating instructions should be adhered.
4. Follow Instructions — All operating and use instructions should be followed.
5. Water and Moisture — The appliance should not be used near water — for example, near a bathtub, washbowl, kitchen sink, laundry tub, in a wet basement, or near a swimming pool, etc.
6. Carts and Stands — The appliance should be used only with a cart or stand that is recommended by the manufacturer.
7. Wall or Ceiling Mounting — The appliance should be mounted to a wall or ceiling only as recommended by the manufacturer.
8. Ventilation — The appliance should be situated so that its location or position does not interfere with its proper ventilation. For example, the appliance should not be situated on a bed, sofa, rug or similar surface that may block the ventilation openings; or placed in a built-in installation, such as a bookcase or cabinet that may impede the flow of air through the ventilation openings.
9. Heat — The appliance should be situated away from heat sources such as radiators, heat registers, stoves, or other appliances (including amplifiers) which produce heat.
10. Power Sources — The appliance should be connected to a power supply only of the type described in the operating instructions or as marked on the appliance.
11. Grounding or Polarization — Precautions should be taken so that the grounding or polarization means of an appliance is not defeated.
12. Power-Cord Protection — Power-supply cords should be routed so that they are not likely to be walked on or pinched by items placed upon or against them, paying particular attention to cords at plugs, convenience receptacles, and the point where they exit from the appliance.
13. Cleaning — The appliance should be cleaned only as recommended by the manufacturer.
14. Nonuse Periods — The power cord of the appliance should be unplugged from the outlet when left unused for a long period of time.
15. Object and Liquid Entry — Care should be taken so that objects do not fall and liquids are not spilled into the enclosure through openings.
16. Damage Requiring Service — The appliance should be serviced by qualified service personnel when:
 - A. The power-supply cord or the plug has been damaged; or,
 - B. Objects have fallen, or liquid has been spilled into the appliance; or,
 - C. The appliance has been exposed to rain; or,
 - D. The appliance does not appear to operate normally or exhibits a marked change in performance; or,
 - E. The appliance has been dropped, or the enclosure damaged.
17. Servicing — The user should not attempt to service the appliance beyond that described in the operating instruction. All other servicing should be referred to qualified service personnel.

On Cassette Tapes

Precautions

1. C-120 cassettes (playing time one hour per side) contain extremely thin tape which breaks or snarls easily, is sometimes subject to stretching and also is of low sensitivity. Therefore, C-120 cassettes are not recommended for high-fidelity recording.
2. Do not pull out the tape from the cassette housing.
3. Be careful not to turn the cassette reels with the fingers, causing tape slackening.
4. Store cassette tapes away from heat, high humidity, dust, and magnetic fields such as caused by speakers, TV sets etc.

Cassette Tabs

You can protect valuable recordings from accidental erasure and re-recording by completely removing the appropriate tab on the top edge of the cassette. The tab for each side is located on the top left-hand

corner as you face the side. Use a small screwdriver, and push the tab down to break it off. Do not leave the broken tab in the recess. If you wish at a later date to record over a side for which the tab has been removed, cover the tab opening with a piece of adhesive tape.

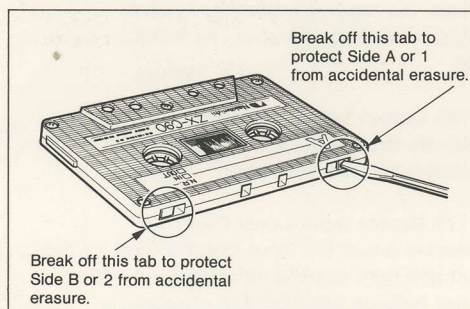

Cassette Insertion and Removal

(1) Insertion of a Cassette

1. When the eject button is pushed in the stop mode, the cassette holder opens.
2. Insert the cassette into the holder with the exposed tape facing down and the

label of the desired side facing you.

3. Gently push the cassette holder back into the panel.
 - For protection of the tape and tape transport, do not press the eject button in any mode other than the stop mode.

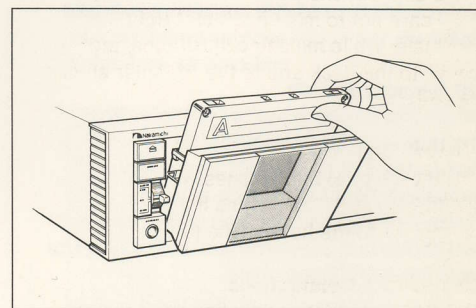

(2) Removal of a Cassette

1. Press the stop switch.
2. When the eject button is pushed, the cassette holder opens.
3. Remove the cassette.

Controls and Features

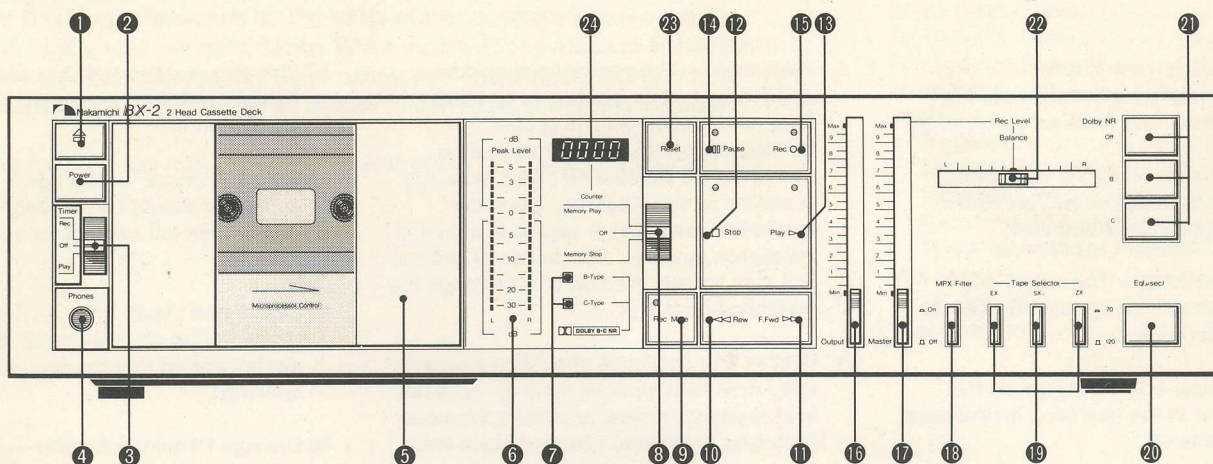

(1) Eject Button

By depressing this button, the cassette holder is opened for insertion and removal of a cassette.

(2) Power Switch

Pressing this switch activates the deck. Depressing it once more switches the power off. When the power is switched on, the stop switch indicator lights up.

(3) Timer Switch

This switch permits unattended recording or automatic playback in conjunction with an external audio timer.

(4) Headphone Jack

Accepts standard stereophone plug.

(5) Cassette Holder

The cover can be easily removed for routine cleaning of heads etc. (→p. 7)

(6) Peak Level Meters

Provide exact indication of peak levels in the range of -30 dB to +5 dB.

(7) Dolby NR Indicators

When the Dolby B-Type NR or the Dolby C-Type NR is used, the respective indicator lights up.

(8) Memory Switch

When this switch is set to "Memory Stop", the tape is stopped from rewind or fast-forward at the "0000" tape counter indication. When the switch is set to "Memory Play" and the tape is rewound or fast-forwarded, playback automatically starts from the "0000" indication.

(9) Rec Mute Switch

By depressing this switch during recording, the input signal can be temporarily cut off. During operation, the indicator lights up.

(10) Rewind Switch

For rapid tape winding in the reverse direction, press the <<< section of the switch.

(11) Fast-Forward Switch

For rapid tape winding in the forward direction, press the >>> section of the switch.

(12) Stop Switch

When the □ section is pressed, the tape motion comes to a full stop and the indicator lights up.

(13) Play Switch

Press the ▷ section of the switch to start playback. When the switch is pressed in the recording-standby mode, recording starts. During operation, the indicator lights up.

(14) Pause Switch

Press the □□ section of the switch for short-term interruption of recording or playback. The indicator lights up. To resume recording or playback, press the play switch.

(15) Record Switch

Press the ○ section of the switch for recording. This deck possesses a one-touch recording-standby feature. By simply pressing the record switch from the stop mode, the recording-standby mode is entered. During operation, the indicator lights up.

(16) Output Level Control

Adjusts the line output level and the headphones listening level.

(17) Master Input Level Control

Used to adjust the input (record) level for the left and right channel simultaneously. The level balance between both channels in recording is adjusted with the balance control. The master input level control can also be used to fade in or fade out a recording.

(18) MPX Filter Switch

Used to cut the 19-kHz multiplex carrier signal, which could cause misoperation of the Dolby NR system when recording from FM stereo broadcasts. When recording from other sources, this switch should be set to Off.

(19) Tape Selector Switches

Depending on the tape used for recording, the appropriate position must be selected. Refer to "Matching the Deck to Various Cassette Tapes" on page 5.

(20) Equalizer Switch

Depending on the tape used for recording or playback, the appropriate position must be selected. Refer to "Matching the Deck to Various Cassette Tapes" on page 5.

(21) Dolby NR Switches

Used to select the noise reduction system, if desired: either the Dolby B-Type NR for a 10-dB improvement in mid- and high-frequency S/N ratio or the Dolby C-Type NR for a 20-dB improvement. If a Dolby NR system is used, the respective Dolby NR indicator lights up.

(22) Balance Control

Serves to adjust the level balance between left and right channel in recording.

(23) Counter Reset Switch

By pressing this switch, the tape counter indication is reset to "0000".

(24) Tape Counter

Can be used to index sections on the tape and to check the tape's position at a given moment. Starting from the "0000" indication, count is carried out up to "9999" in the record, playback and fast-forward modes ("plus count") and down to "-999" in the rewind mode ("minus count").

Precautions

- After the power to the deck is switched on, the tape control buttons are inoperative for appr. 4 seconds, until all circuits have become stable.
- After timer recording or timer playback is completed, the eject button may not be operative. To eject the tape in such a case, do not press the button forcibly. Set

the timer switch to Off, and the power switch to On. The button is now operative and the tape can be removed.

(3) Voltage Selector

AC voltage is factory-set for the country in which you purchased your BX-2. The voltage selector permits re-setting of mains voltage in case the deck is to be used in a different

country.

Note: Safety regulations in certain countries prohibit inclusion of a voltage selector. This feature, therefore, may be absent from your deck.

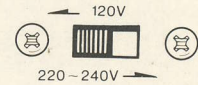

Operation

Check once more whether all connections between amplifier and cassette deck have been properly established.

[Playback]

- Confirm that the timer switch is set to Off. Switch on the power and insert the cassette to be played into the cassette holder.
- Set the equalizer switch to the appropriate position for the tape in use.
- If the tape to be played back was recorded with Dolby C-Type noise reduction, press the "C" switch of the Dolby NR switches. If the tape was recorded with Dolby B-Type noise reduction, press the "B" switch. The respective Dolby NR indicator lights up. If the tape to be played back was not recorded with Dolby noise reduction, press the "Off" switch.
- Press the \triangleright section of the play switch.

- Adjust the desired volume with the output level control.
- When the tape end is reached, the auto-shutoff mechanism automatically stops the tape transport. If you want to remove the tape during playback, first press the \square section of the stop switch. For temporary interruption of playback, press the $\square\square$ section of the pause switch. To resume playback, press the play switch again.
 - The logic-controlled transport of this deck permits going from any transport mode into any other (i.e. from play to rewind, from rewind to fast-forward, etc.) without using the stop switch.
 - During playback the peak level meters display the level recorded on the tape. Readings are not affected by turning the output level control.

[Matching the Deck to Various Cassette Tapes]

Tape Selector Switch and Eq Switch Settings (Recommended Tapes)

EX/120 μ S Position

Tape Selector Switch	Eq Switch	Brand Name	
Tape Selector 	Eq(μ ,sec) 	Nakamichi	EX
		Nakamichi	EX II
		TDK	AD, AD-X
		Maxell	UD, UD-XLI, XL-IS
		Fuji	FR-I
		AMPEX	GM-I

SX/70 μ S Position

Tape Selector Switch	Eq Switch	Brand Name	
Tape Selector 	Eq(μ ,sec) 	Nakamichi	SX
		TDK	SA-X
		Maxell	UD-XLI, XL-IIS
		Fuji	FR-II
		AMPEX	GM-II

ZX/70 μ S Position

Tape Selector Switch	Eq Switch	Brand Name	
Tape Selector 	Eq(μ ,sec) 	Nakamichi	ZX
		TDK	MA, MA-R
		Maxell	MX
		Fuji	FR-Metal
		AMPEX	MPT

- This cassette deck will achieve best results with Nakamichi ZX, SX and EX II cassette tapes. Therefore the use of these tapes whenever possible is

recommended.

If other tapes are used, it is desirable to choose tapes from this list.

Memory Switch

By setting the memory switch to "Memory Play", playback automatically starts from the "0000" tape counter point when the tape is rewound or fast-forwarded. By setting the switch to "Memory Stop", tape motion during rewind or fast-forward automatically stops when the "0000" point is reached.

Dolby NR System

This deck incorporates both the Dolby B-Type and the Dolby C-Type noise reduction systems, which can be freely selected. The Dolby B-Type NR provides approximately 10 dB of noise reduction in the high frequencies. The Dolby C-Type NR achieves a S/N ratio improvement of appr. 20 dB in the range from 2 kHz to 8 kHz, where noise is most readily audible. For playback of a tape which was recorded with Dolby B-Type NR, the Dolby NR "B" switch has to be pressed. For playback of a tape recorded with Dolby C-Type NR, the "C" switch must be pressed.

- The Dolby NR system does not reduce any noise already contained in the source signal. You should therefore use recording sources which are as noise-free as possible.

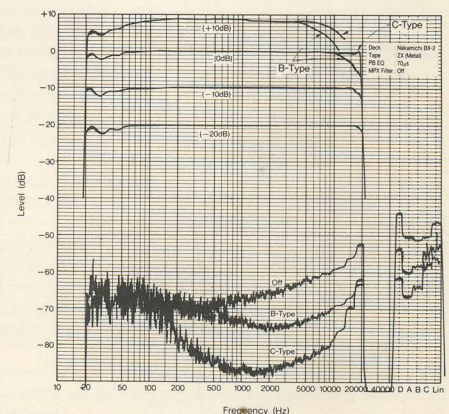

Frequency Response and Noise Spectrum Analysis

[Recording]

- (1) Confirm that the timer switch is set to Off. Switch on the power and insert the cassette to be used for recording into the cassette holder.
- (2) Set the tape selector switches and the equalizer switch according to the tape in use. (→ "Matching the Deck to Various Cassette Tapes")
- (3) If the Dolby C-Type NR is to be used, press the "C" switch of the Dolby NR switches. If the Dolby B-Type NR is to be used, press the "B" switch. The respective Dolby NR indicator lights up. If no Dolby noise reduction is to be used, press the "Off" switch. When recording from FM broadcasts, set the MPX filter switch to On.
- (4) Pressing the counter reset switch to bring the tape counter indication to "0000" is convenient to easily re-locate the starting point of the recording or use the Memory Play feature.
- (5) By pressing the \bigcirc section of the record switch, the deck automatically goes into the recording-standby (Rec/Pause) mode. The red \bigcirc indicator in the record switch and the green $\square\square$ indicator in the pause switch light up.
- (6) While watching the peak level meters, adjust the recording level by gradually sliding up the master input level control and adjusting the left/right channel balance with the balance control. For hints on proper level settings, refer to the paragraph "Record Level Setting".
- (7) When the \triangleright section of the play switch is pressed, recording starts.
- (8) When the tape end is reached, the auto-shutoff mechanism automatically stops the tape transport. If you want to remove the tape during recording, first press the \square section of the stop switch.

For temporary interruption of recording, press the $\square\square$ section of the pause switch. To resume recording, press the play switch again.

- By pressing the \triangleright section of the play switch while keeping the \bigcirc section of the record switch depressed, recording can be started immediately without entering the standby mode.
- If the record switch is pressed after the play switch, the recording mode cannot be entered.

■ Rec Mute

By pressing the Rec Mute switch during recording, the tape continues to run in the record mode, but the input signal is cut off and the indicator lights for as long as the switch is being kept depressed. This can be used to insert blank spaces on a tape, etc. The line output and the headphone output are not muted during this operation, so that it is possible to continuously monitor the input signal.

■ Record Level Setting

This deck's LED level meters are free of "overshoot" problems and display peak levels with a high degree of accuracy.

"Normal" (LH) position tape formulations, "Chrome" position tape formulations:

Adjust record levels so that the +3 dB indication lights up only occasionally on the highest signal peaks.

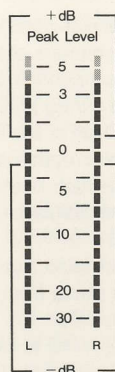

For good recordings, it is essential to maintain a high signal-to-noise ratio. If the record level is set too low, tape hiss will impair the playback sound quality. On the other hand, setting the record level too high will cause distortion. Refer to the chart below as a guideline to set recording levels.

The Dolby C-Type NR system incorporated in this deck possesses advanced circuitry to prevent distortion even at high saturation levels. Therefore recording levels can be set in the same way as without noise reduction.

"Metal" position tape formulations:

Adjust record levels so that the +5 dB indication lights up only occasionally on the highest signal peaks.

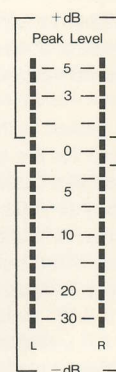

As different tape formulations have slightly different overload (headroom) characteristics, the requirements may vary to a certain degree when using different tapes.

[Timer Recording or Playback]

This deck incorporates a timer-start feature, which enables you to make unattended recordings or start playback at a pre-selected time with the use of a timer.

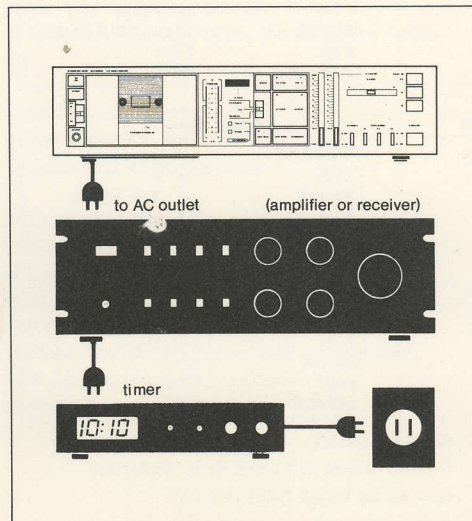

- (1) Establish connections as shown in the chart.
- (2) Insert the tape to be used for recording or playback and turn on the power to all components.
- (3) For timer recording, set the recording level to suit the expected signal. For timer playback, set the output control to the desired level. Check if all components are set up properly.
- (4) For timer recording, set this deck's timer switch to "Rec". For timer playback, set the switch to "Play".
- (5) Set the timer to the desired operation time.
- (6) At the pre-selected time, the timer will supply power to the components, and the deck will automatically start recording or playing.
 - Be sure to set the deck's timer switch to "Off", when the timer recording or playback feature is not desired.

Maintenance

Head and Transport Cleaning

It is very important to regularly clean the surfaces of the heads as well as the capstan, pinchroller and all other parts which come in contact with the tape. Tiny particles shedded from the tape onto these parts, as well as dust accumulations etc. become the cause of drop-outs, and severely degrade frequency response and wow-and-flutter characteristics.

Cleaning Procedure

Remove the cassette holder cover. Use cotton-tipped sticks or the like (available in audio stores, etc.) to carefully and with very light pressure clean the parts indicated in white on the illustration. In cases of severe contamination, dip the cotton tip in cleaning fluid. Cleaning is facilitated if — after removing the cassette holder cover — the cover is closed again and the pause switch depressed, thereby raising the head assembly.

If the pressure roller is very dirty, press the pause switch and clean the roller while it is turning. At this time, be careful that the cotton tip does not get caught between the roller and the capstan. After cleaning the roller, put the deck into the pause mode again and clean the revolving capstan.

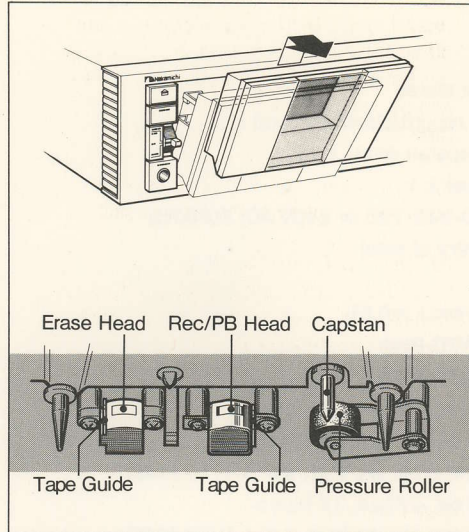

- Be careful not to apply too much force in cleaning as the respective parts are critically aligned. Take special care not to damage the tape guides.
- Do not use too much cleaning fluid and give the cleaned surfaces some time to dry off completely before playing a tape.
- When you have used cotton-tipped sticks, be careful not to leave any cotton strands on the cleaned parts.

Demagnetizing

After a longer period of use, there can be a build-up of residual magnetism in heads and capstan, etc. Such residual magnetism can induce noise and impair the high frequencies during playback. To prevent this, you should demagnetize these parts about once every 50 hours of use with the optional Nakamichi DM-10 Demagnetizer or another properly designed demagnetizer. For details on the demagnetizing procedure, please consult the demagnetizer's instruction manual.

- Always switch off the power to the deck before starting the demagnetizing procedure.

Cleaning the Faceplate

This unit should be cleaned only by wiping it with a soft, dry cloth. Never use alcohol, solvents, ammonia or abrasive cleaning agents.

Lubrication

All important moving parts of this deck are fitted with long-life, oil-less bearings. Periodic lubrication is therefore not necessary.

Troubleshooting

Condition	Probable Cause	Remedy
Tape does not run.	1. Cassette holder not completely locked.	1. Press eject button and then close cassette holder firmly.
Record mode cannot be entered.	2. Cassette tabs have been removed.	2. Place adhesive tape over tab opening or use new cassette.
Excessive playback hiss.	3. Head is magnetized.	3. Demagnetize head.
Uneven sound levels, drop-outs, excessive wow/flutter.	4. Heads and/or capstan and pressure roller dirty. 5. Faulty cassette.	4. Clean these parts. 5. Replace cassette.
Incomplete erasure.	6. Erase head dirty.	6. Clean head and pressure roller.
Distorted record/playback sound.	7. Program material itself is distorted. 8. Recording levels are too high. 9. Head dirty. 10. Wrong setting of tape selector switches.	7. Check program material. 8. Wide dynamic range permits some short-term overload, but excessive recording levels will cause distortion. Adjust recording levels. 9. Clean head. 10. Select correct setting for the tape in use.
Record mode is entered, but cannot record.	11. Input disconnected. 12. Head dirty.	11. Check connections. 12. Clean head.
Cannot playback.	13. Output disconnected. 14. Head dirty.	13. Check connections. 14. Clean head.
Dull high frequencies.	15. Head dirty. 16. Tape selector switches and/or equalizer switch not set correctly.	15. Clean head. 16. Select correct positions for tape in use.
Hum heard during recording or playback.	17. Strong induction fields near deck. 18. Signal cable or connector grounding faulty.	17. Keep deck away from amplifier, transformers, fluorescent lamps, etc. 18. Replace signal cables.

Specifications

Specifications

Track Configuration.....	4 tracks/2-channel stereo
Heads.....	2 (erase head x 1, record/playback head x 1)
Motors (Tape Transport).....	DC servo motor (capstan drive) x 1 DC motor (reel drive) x 1
Power Source.....	100, 120, 120/220-240, 220 or 240V AC; 50/60Hz (According to country of sale)
Power Consumption.....	23 W max.
Tape Speed.....	1-7/8 ips. (4.8 cm/sec.) ±0.5%
Wow-and-Flutter.....	Less than 0.11% WTD Peak Less than 0.06% WTD RMS
Frequency Response.....	20 Hz-20,000 Hz (recording level - 20 dB)
Signal-to-Noise Ratio.....	Dolby C-Type NR on <70μs, ZX tape> Better than 68dB (400 Hz, 3% THD, IHF A-WTD RMS) Dolby B-Type NR on <70μs, ZX tape> Better than 62dB (400 Hz, 3% THD, IHF A-WTD RMS)
Total Harmonic Distortion.....	Less than 1.0% (400 Hz, 0 dB, ZX, EX II tape) Less than 1.2% (400 Hz, 0 dB, SX tape)
Erasure.....	Better than 60 dB (100 Hz, 0 dB)
Separation.....	Better than 36 dB (1 kHz, 0 dB)
Crosstalk.....	Better than 60 dB (1 kHz, 0 dB)
Bias Frequency.....	105 kHz
Input (Line).....	50 mV, 30 kΩ
Output (Line).....	0.5V (400 Hz, 0 dB, output level control at max.) 2.2 kΩ
(Headphones).....	2.2 mW (400 Hz, 0 dB, output level control at max.) 8 Ω load
Dimensions.....	430(W) x 110(H) x 250(D) millimeters 16-15/16(W) x 4-5/16(H) x 9-7/8(D) inches
Approximate Weight.....	5.5 kg 12 lb. 2 oz

- Specifications and appearance design are subject to change for further improvement without notice.
- Dolby NR under license from Dolby Laboratories Licensing Corporation.
- The word "DOLBY" and the Double-D-Symbol are trademarks of Dolby Laboratories Licensing Corporation.

Optional Accessories

ZX Cassette Tape C-60, C-90
SX Cassette Tape C-60, C-90
EX II Cassette Tape C-60, C-90
EX Cassette Tape C-60, C-90

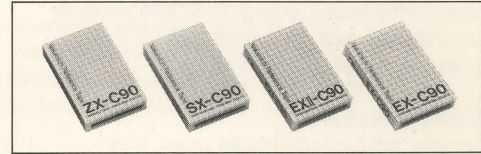

DM-10 Head Demagnetizer

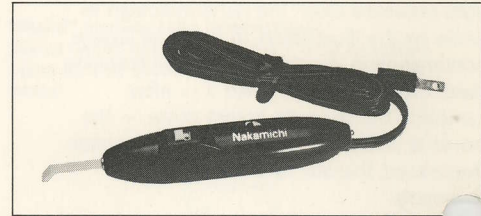

SP-7 Stereo Headphones



Nakamichi Corporation

Tokyo Office
Shinjuku Daiichi Seimei Bldg.
2-7-1 Nishishinjuku, Shinjuku-ku, Tokyo
Phone : (03) 342-4461
Telex : 2324721 (NAKAM J)

Nakamichi U.S.A. Corporation

1101 Colorado Avenue
Santa Monica, Calif. 90401
Phone : (213) 451-5901
Telex : 652429 (NAKREI SNM)

Nakamichi U.S.A. Corporation

220 Westbury Avenue
Carle Place, N.Y. 11514
Phone : (516) 333-5440